

# **T-K2 Instantaneous Water Heater** **TAKAGI Installation Manual and Owner's Guide**



**Flash Water Heater™**  
**Model T-K2**

*Suitable for potable water heating and space heating*

## **FEATURING**

- ENDLESS HOT WATER
- ON DEMAND
- COMPACT, SPACE SAVING
- ENERGY CONSERVING
- COMPUTER CONTROLS
- COMPUTERIZED SAFETY
- NO PILOT LIGHT

## **WARNING**

This product must be installed and serviced by a licensed plumber, a licensed gas fitter, or a professional service technician and/or in accordance with all local code. Improper installation and/or operation, or installation by an unqualified person, will void the warranty.

## **WARNING**

Operation of this unit creates carbon monoxide gas and flue gases which can cause serious injury or death. In addition, if the information in this manual is not followed exactly, a fire or explosion may result causing property damage, personal injury or death.

Takagi Industrial Co. USA Inc.  
5 Whatney  
Irvine, CA 92618  
Toll Free (888) 882-5244 USA  
Toll Free (877) 877-4953 CANADA  
[www.Takagi.com](http://www.Takagi.com)

## CONTENTS

Specification	..... 2
Introduction	.....3
For your safety	.....3-4
Installation	..... 5
• General	..... 5
• Accessories	..... 5
• Outdoor Installation	.....5-6
• Indoor Installation	.....6-7
• Venting Instructions	.....7 -9
• Gas Supply/Gas Pipe sizing.....	10-11
• Water Connection	..... 11-12
• Electrical Connection	..... 12
• Initial operation	..... 13
Normal operation	..... 13
• Flow	..... 13-14
• Temperature setting	..... 14
• Freeze Protection Device	..... 14-15
• Maintenance and Service	.....15-16
• Error codes	.....16
Wiring diagram	.....17
For your Safety	.....18
Danger	.....19
Application	.....20
• Space Heating	.....20
• Dual-purpose heating	.....21
• Storage Tank	.....22
• Re-Circulation	.....22
Optional Items	.....23
Component Diagram	.....24-26
Parts list	.....27
Output temperature Chart	.....28

## SPECIFICATIONS

Natural Gas Input	Min. 20,000 Btu Max. 185,000 Btu
LPG Input	Min. 19,000 Btu Max. 175,000 Btu
Gas Connection	3/4" NPT
Water Connections	3/4" NPT
Water Pressure	Min. 15 psi Max. 150 psi
Natural Gas Pressure Inlet	Min. 5" WC Max. 10.5" WC
LP Gas Pressure Inlet	Min. 11" WC Max. 14" WC
Manifold Pressure	Natural 2.3" WC Propane 2.5" WC
Weight	60 lbs.
Dimensions	25"x16.5"x8.3"
Ignition	Electronic Ignition
Electrical Supply	AC 120 V

### \*\*\* NOTE \*\*\*

- Check the rating plate to ensure this product matches your specifications;
- This appliance is certified for use at altitudes from 0ft to 4500ft (1,370m) in accordance to the latest CAN/CGA 2.17-High Altitude Installation procedures at normal manifold pressure 2.3" W.C. (Natural Gas). Do not alter the orifice jets or gas supply pressure. At altitudes of 4500ft to 5,000ft (1524m) lower the manifold pressure to 2.1" W.C. (Natural Gas). At 5000ft to 6000ft (1,829m), lower the manifold pressure to 1.9" W.C. (Natural Gas). For elevations above 6000ft or for specific instructions on how to lower the manifold pressure, please call the Takagi office

**Manufacturer reserves the right to discontinue, or change at any time, specifications or designs without notice and without incurring obligations.**

## INTRODUCTION

This manual provides information necessary for the installation, operation, and maintenance of the Model T-K2 water heater. This unit includes a fan enabling sidewall (power) venting and an advanced electronic ignition system.

The model description is listed on the rating plate which is attached to the front cover of the water heater. Please read all installation instructions completely before installing this product. If you have any problems or questions regarding this equipment, consult with Takagi or its local representative. Experiences have shown that most operating problems are caused by improper installation.

The T-K2 Water Heater is an instantaneous, tankless water heater designed to supply endless hot water to your entire household and/or commercial facility utilizing total efficiency. The principle behind the T-K2 Water Heater is simple. Once you open a hot water tap, water flows through the T-K2 Water heater. Once a minimum of 0.75 GPM is achieved, the flow sensor automatically commands the computer to turn on the fan, activate the electronic igniter and open the gas valves. The computer monitors water temperature, water flow rate and gas flow to ensure that you get the right amount of hot water at the correct hot water temperature. After the burners are ignited, the "fire on" lamp is lit. The computer will modulate the gas supply valve and water flow. 0.75 gallons per minute is required to turn the burners on; after the burners are ignited, the flow rate can be lowered to 0.6 gallons per minute to maintain the heater on. It is advisable to open further the cold tap rather than decreasing the hot tap to adjust the water temperature. As long as you have water, gas and electricity, you will get an endless flow of hot water. Open a hot water tap to turn on your water heater. Close the tap to turn off your water heater.

## FOR YOUR SAFETY

The installer is responsible for the correct installation of your Flash T-K2 Water Heater. Installation and service must be performed by a qualified installer (for example, a licensed plumber or gas fitter) otherwise the warranty by Takagi will be void.

PLEASE READ THIS MANUAL CAREFULLY  
AND FOLLOW ALL DIRECTIONS.

1. Follow all local codes, or in the absence of local codes, follow the most recent edition of the National Fuel Gas Code, ANSI Z223.1/NFPA 54 in the USA or the CAN/CSA B149.1 Natural Gas and Propane Installation Code in Canada.
2. Properly ground the unit in accordance with all local codes or in the absence of local codes, with the National Electrical Codes, ANSI/NFPA 70 in the USA or CSA standard C22.1 Canada Electrical Code Part 1 in Canada.
3. Carefully plan where you intend to install your T-K2 Water Heater. Ensure that your heater will have enough combustible air and proper ventilation and locate your heater where water leakage will not do damage to surrounding areas. If there is a possibility of water damage, install a suitable drain pan under the unit which will not restrict combustible airflow.
4. Check the rating plate for the correct gas type, gas pressure, water pressure and electrical rating. If this unit does not match your requirements, do not install.

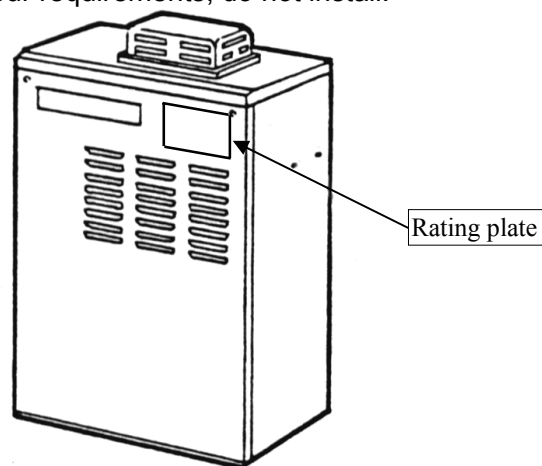

5. If any problem should occur, turn off all hot water taps and turn off the gas. Then call a trained technician or the Gas Company or the manufacturer.
6. **WARNING:** Do not disconnect the electrical supply if the ambient temperature will drop below freezing. The Freeze Prevention Device only works if the unit has electrical power. The Freeze Prevention Device is rated for temperatures down to 5 °F (-15 °C) in a wind free environment. Refer to the section on Winterizing and the Freeze Prevention Device for more information. The Warranty will not be covered if the heat exchanger is damaged due to freezing.
7. **WARNING:** Water temperatures over 125°F can cause severe burns instantly or death from scalding. The water temperature is set at 122°F (50°C) from the factory to minimize any scalding risk. Before bathing or showering always check the water temperature.
8. **WARNING:** Do not use this appliance if any part has been in contact with or been immersed water. Immediately call a trained technician to inspect and/or service the unit if necessary.
9. **WARNING:** Do not store or use gasoline or other flammables, vapors or liquids in the vicinity of this appliance.
10. **WARNING:** Do not reverse the water and/or gas connections as this will damage the gas valves and can cause severe injury or death. Following the diagram below when installing your water heater:

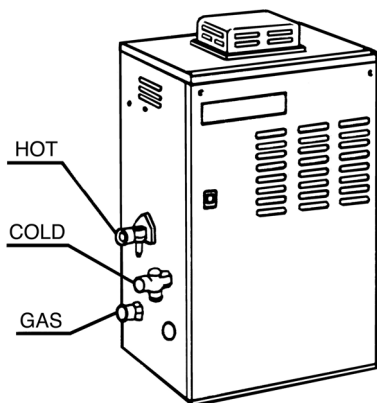

## GENERAL

The T-K2. Water Heater is an instantaneous, tankless water heater designed to supply endless hot water to your entire household and/or commercial facility utilizing total efficiency. The principle behind the T-K2 Water Heater is simple. Once you open a hot water tap, water flows through the T-K2 Water heater. Once a minimum of 0.75 GPM is achieved, the flow sensor automatically commands the computer to turn on the fan, activate the electronic igniter and open the gas valves. The computer monitors water temperature, water flow rate, and gas flow to insure that you get the right amount of hot water at the correct hot water temperature. After the burners are ignited, the "fire on" lamp is lit. The computer will modulate the gas supply valve and water flow 0.75 gallons per minute is required to turn the burners on; after the burners are ignited, the flow rate can be lowered to 0.6 gallons per minute to maintain the heater on. It is advisable to increase the cold tap rather than decreasing the hot tap to adjust the water temperature. As long as you have water, gas and electricity, you will get an endless flow of hot water. Open a hot water tap to turn on your water heater. Close the tap to turn off your water heater.

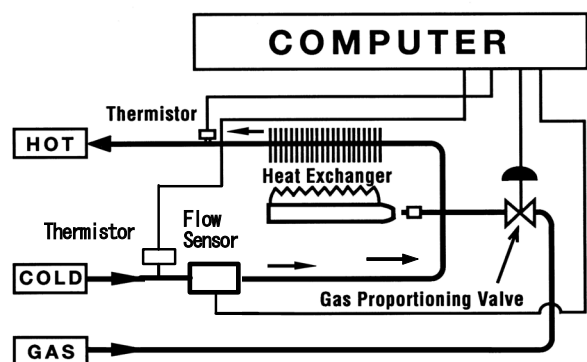

## INSTALLATION







### GENERAL

All gas water heaters require careful and correct installation to ensure safe and efficient operation. This manual must be followed exactly. Read the "For Your Safety" section at the beginning of this manual.

1. The gas regulator is preset at the factory; it is computer controlled and should not need adjustment;
2. Maintain proper space for servicing. Install the unit so that it can be connected or removed easily;
3. The electrical connection requires a means for switching off the power supply;
4. If you will be installing the unit in a contaminated area with a high level of dust, sand, flour, aerosols or other contaminants, they can become airborne and enter and buildup within the fan and burner causing damage to the unit. The warranty will not cover damage caused to the unit due to installation in a contaminated environment that has not been converted.
5. Particles from these objects may clog the air vent or reduce the functions of the rotating fan and cause improper burning of the gas. Regular maintenance is recommended for these types of environment.
6. Do not install the unit where the exhaust vent is pointing into any opening in a building or where the noise may disturb your neighbors. Make sure the vent termination is 4 feet from a doorway or opening to prevent exhaust from entering.
7. Some chemicals used in a beauty salon may affect the flame sensor. Water heater may not work properly. Please consult with Takagi, when the water heater is installed in a beauty salon.
8. Water hardness may affect the water heater. Water heater may be damaged. The warranty will not cover damage caused by water quality.

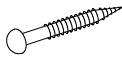
## Accessories

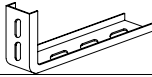
Check that the installation manual, the extension cable and the warranty card were included with the unit.

PARTS NAME	SHAPE	NUMBER
MANUAL		1
WASHERS		4
SCREWS		4
ANCHORS		4
WALL MOUNT BRACKET		2
EXTENSION CABLE		1

### OUTDOOR INSTALLATION

















Follow all local codes, or in the absence of local codes, follow the most recent edition of the National Fuel Gas Code ANSI Z223.1/NFPZ 54 in the USA or the CAN/CSA B149.1 Natural gas and Propane installation Code in Canada.

Ensure that the unit is set for outdoor installation. The 'OUT' dipswitch on the computer board should be switched to its 'ON' position:

#### Indoor or Outdoor dip switch setting

The outdoor vent cap must be used when unit is installed outdoor. Takagi recommends the use of its part No. TK-TV04.

Locate the water heater in an open, unroofed area and maintain the following minimum clearances:

	INDOOR DEFAULT	OUTDOOR
113		
104		
NG		
LP		
OUT		
IN		
176		
		

### Outdoor Installation Service Clearances

Left side of heater	12"
Front (Maintenance space)	24"
Back of heater	1"
Right side of heater	6"
Top of heater	36"

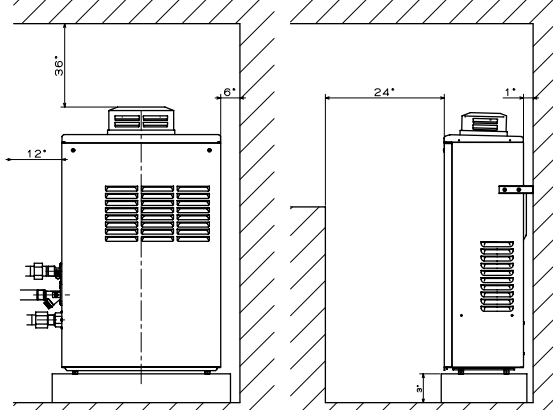

**WARNING:** Do not install this water heater under an overhang less than 3 feet from its top or eaves. The area under an overhang must be open to three sides

**WARNING:** Do not have the vent terminal pointing toward any opening into a building. Do not locate your heater in a pit or location where gas and water can accumulate.

**WARNING:** Do not install the heater where water, debris or flammable vapors may get into the flue terminal. This may cause damage to the heater and void the warranty.



**WARNING:** Do not install the water heater vent terminator within 4 feet in the USA of any air intake or building opening, and within 3 feet in Canada of any air intake or building opening. (Refer to Page.9)

### INDOOR INSTALLATION

When installed indoors, the T-K2 water heater shall be located in an area to maintain the following minimum clearances around the unit:

#### Indoor Installation Service Clearances

Left side of heater	6"
Front (Maintenance space)	24"
Back of heater	1"
Right side of heater	2"
Top of heater	12"

### Wall Hanging Installation

For a wall mount installation, use TK-BK01 brackets to securely attach the T-K2 to the wall.

Locate the heater as desired, but follow all applicable local codes, as well as the indoor or outdoor clearances that apply to the installation.

### Standing Installation

If the unit is to be installed standing on a surface, adjust the legs so that the unit stands securely and is level (legs can be adjusted up to 1").

Do not install the unit standing directly on a combustible surface. Use a 3" non-combustible base.

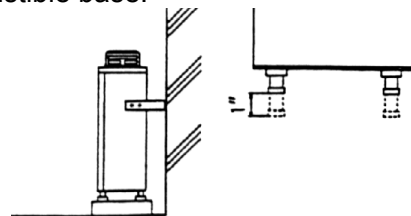

Use the included L brackets to connect the unit to a wall to ensure that it does not fall over. These brackets will maintain the required 1" clearance between the back of the unit and a combustible surface.

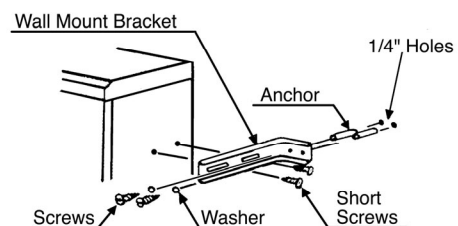

## Combustion Air Supply

The water heater location must provide enough air for proper combustion and ventilation of the surrounding area. See the latest edition of ANSI Standard Z223.1 or any applicable local codes. In general, these requirements specify that if the unit is installed in a confined space, there must be a permanent air supply opening.

### Air Supply from Outside Building

When combustion air is supplied from outside the building, an opening communicating directly with the outside should have a minimum free area of one square inch per 15,000 BTUH input of the total input rating of water heater in the enclosed area.

### Air Supply from Inside Building

When combustion air is supplied from inside the building, an opening communicating with the rest of the dwelling should have a minimum free area of one square inch per 1000 BTUH input of the total input rating of water heater in the enclosed area. These openings should never be less than 100 sq. in.

### Minimum recommended air supply opening size for water heater:

Water heater size	When drawing make-up air from outside the building	When drawing make-up air from inside the building (from other rooms within)
Max. 185,000 BTU	12.3 Sq. IN	185 Sq. IN

### Combustible Air Supplied by Mechanical fan or Make up air device.

The T-K2 water heater is equipped with a combustible air sensor that will shut off the unit when inadequate combustible air supply to unit is detected.

If a mechanical fan or make up air device is used to supply air to the water heater or utility room, the installer should make sure it does not create drafts which could cause nuisance shutdowns. If a blower is necessary to provide adequate combustion air to the water heater, a switch or equivalent device must be wired (interlocked) with the water heater control circuit or other proper devices to prevent the water heater from firing unless the blower is operating.

## VENTING INSTRUCTIONS

### General

**WARNING:** Improper venting of this appliance can result in excessive levels of carbon monoxide which can result in severe personal injury or death.

This water heater must be vented in accordance with the section "Venting of Equipment" of the latest edition of the Natural Fuel Gas Code, ANSI Z223.1 and all applicable local building codes. In Canada, follow section 7 of the CAN/CSA B149.1 Natural Gas and Propane Installation Code.

### Exhaust Vent

This is a Category III appliance and must be vented accordingly. The vent system must be sealed air tight. All seams and joints must be sealed with high heat resistant silicone sealant or UL listed aluminum adhesive tape having a minimum temperature rating of 350°F. For best results, a vent system should be as short and straight as possible.

This unit requires 4", Category III approved, single wall stainless steel vent pipe or any other Category III approved, non-combustible, corrosion-resistant material. The following are UL listed manufacturers: ProTech Systems Inc. (FasNSeal), Flex-L Inc., Z-Flex Inc. (Z-Vent III) and Heat-Fab Inc. (Saf-T Vent). **Follow the vent pipe manufacturer's instructions when installing the vent pipe.** Do not common vent this appliance with any other vented appliance. The maximum length of exhaust vent piping must not exceed 35 ft. deducting 5 ft. for each elbow used in the venting system. Do not use more than 3 elbows.

Diameter	Max. No. of Elbow	Max. Vertical or Horizontal run in Length
4"	3 Ea.	35 ft

**For each elbow added, deduct 5 ft. from max. Vent length.**

No. of Elbows	Max. Vertical or Horizontal Length
0	35 ft.
1	30 ft.
2	25 ft.
3	20 ft.

When installing the vent system, all applicable national and local codes must be followed. If you install thimbles, fire stops or other protective devices and they penetrate any combustible or noncombustible construction, be sure to follow all applicable national and local codes.

When the horizontal vent run exceeds 5 ft., the following criteria must be observed:

- Support the vent run at 3 ft intervals with overhead hangers.
- Slope the vent run downwards toward the vent terminator at a rate of 1/4" per foot.

### Vent Termination

A sidewall vent terminator must be used when the water heater is vented through a sidewall. Takagi recommends the use of its part No.TK-TV01. The vent terminator provides a means of installing vent pipe through the building wall and must be located in accordance with ANSI Z223.1/NFPA 54, or in Canada with CAN/CSA-B149.1 and local applicable codes.

Locate the vent terminator so that it cannot be blocked by snow. Most codes require that the terminator be at least 12 inches above grade, but the installer may determine if it should be higher depending on the job site condition and applicable codes.

**WARNING:** Improper installation can cause nausea or asphyxiation, severe injury or death from carbon monoxide and flue gases poisoning. Improper installation will void product warranty. For high altitude installation above 4,500 feet, contact Takagi on how to handle this situation.

- Regarding the clearance from the terminator to the air inlet or opening, refer to the next page.
- Install a condensation drain in the venting.
- Follow the vent system to vent manufacture's instruction and local code.
- Do not common vent or connect any vent of appliance to the vent.
- Use the 4" category III Vent pipe approved, single wall stainless steel vent pipe.

General rules for venting the T-K2 water heater are:

1. Place the water heater as close as possible to the vent terminator;
2. The vent collar of the water heater must be fastened directly to an unobstructed vent pipe.
3. Do not weld the vent pipe to the water heater collar.
4. The weight of the vent stack must not rest on the water heater.
5. The vent must be easily removable from the top of the water heater for normal service and inspection of the unit.
6. The water heater vent must not be connected to any other gas appliance or vent stack.
7. Avoid locating the water heater vent terminator near any air intake devices or air-conditioning units. These fans can pick up the exhaust flue products from the water heater and return them to the building. This can create a health hazard.
8. Avoid using an oversized vent pipe or using extremely long runs of the pipe.

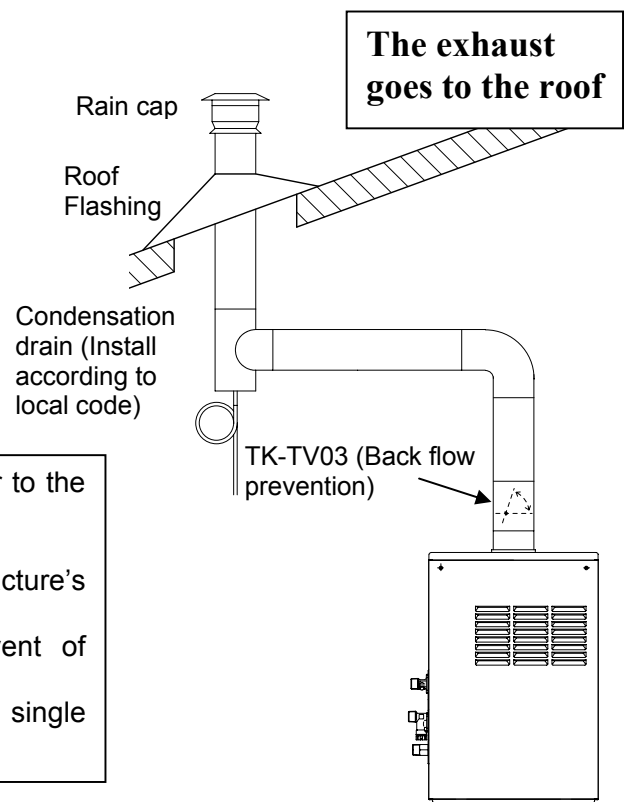



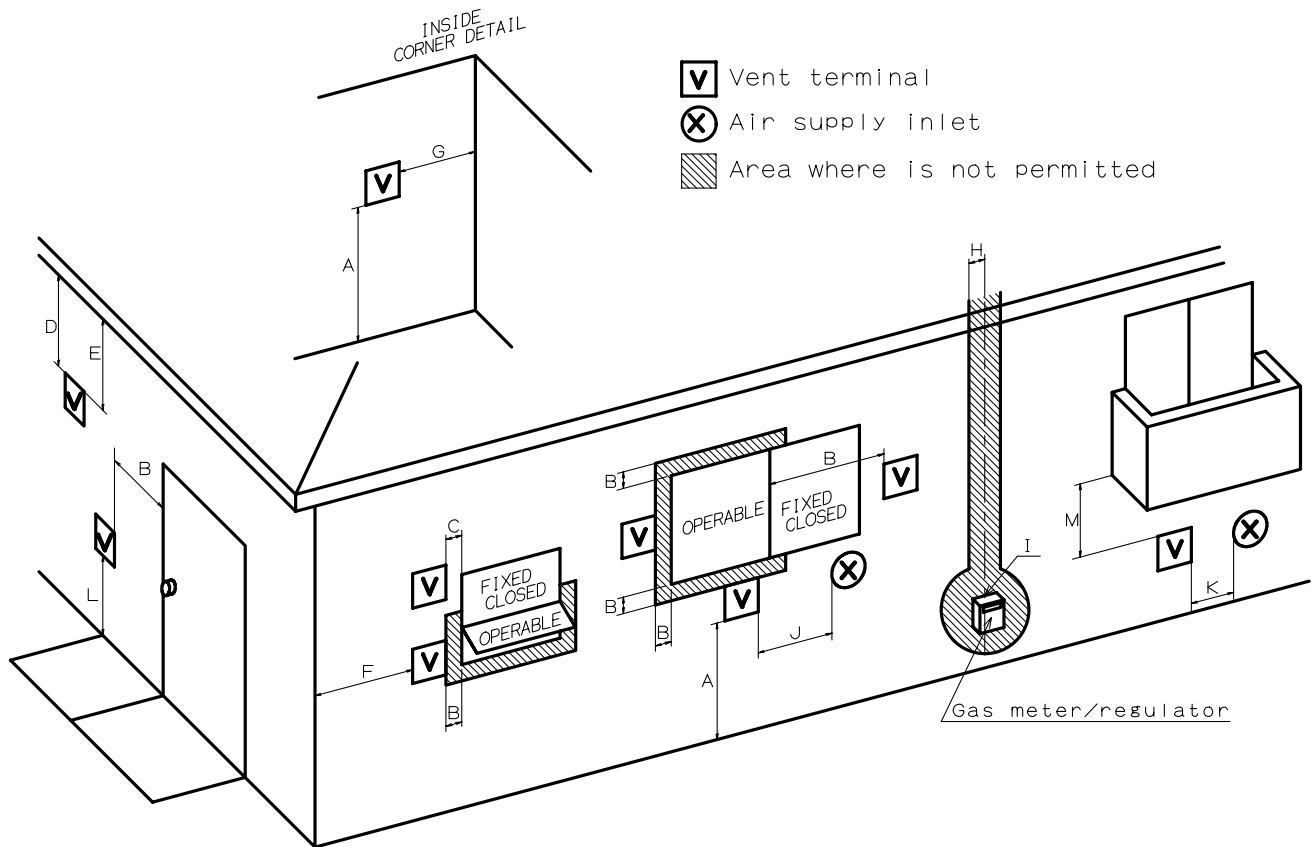

		Canada	U.S.A	
		Direct vent and other than Direct Vent	Direct vent	Other than Direct Vent
A	Clearance above grade, veranda, porch, deck, or balcony.	1 foot	1 foot	1 foot
B	Clearance to window or door that may be opened.	3 feet	1 foot	4 feet from below or side opening. 1 foot from above opening.
C	Clearance to permanently closed window	*	*	*
D	Vertical clearance to ventilated soffit located above the vent terminator within a horizontal distance of 2 feet (61cm) from the center line of the terminator.	*	*	*
E	Clearance to unventilated soffit	*	*	*
F	Clearance to outside corner	*	*	*
G	Clearance to inside corner	*	*	*
H	Clearance to each side of center line extended above meter/regulator assembly	3 feet	*	*
I	Clearance to service regulator vent outlet.	3 feet	*	*
J	Clearance to non-mechanical air supply inlet to building or the combustion air inlet to any other application.	3 feet	1 foot	4 feet from below or side opening. 1 foot from above opening.
K	Clearance to mechanical air supply inlet.	6 feet	3 feet	3 feet
L	Clearance above paved sidewalk or paved driveway located on public property.	7 feet	*	7 feet
M	Clearance under veranda, porch deck, or balcony.	1 foot	*	*

\*For clearances not specified in ANSI Z223.1 / NFPA 54 or CAN/CSA-B149.1, please use clearances in accordance with local installation codes and the requirement of the gas supplier.

## GAS SUPPLY AND GAS PIPE SIZING

### TO TURN OFF GAS TO APPLIANCE

1. Turn off all electric power to the water heater if service is to be performed.
2. Turn the manual gas valve located on the outside of the unit clockwise  $\cup$  to the off position.

### FOR YOUR SAFETY, READ BEFORE OPERATING:

- A. This water heater does not have a pilot. It is equipped with an electronic ignition device that automatically lights the burner. Do not try to light the burner manually;
- B. BEFORE OPERATING, check all around the water heater area for gas leaks. Be sure to check next to the floor as some gases are heavier than air and will settle on the floor;
- C. Use only your hand to turn the gas valve knob. Never use tools. If the knob will not turn by hand, do not attempt to repair it. Call a qualified service technician. Force or attempted repair may result in a fire or explosion.
- D. **WARNING:** Conversion of this unit from natural gas to propane or propane to natural gas cannot be done in the field. Contact your local distributor to get the correct unit for your gas type. Conversion done by anyone other than the manufacturer will void all warranty.

Check that the type of gas matches the rating plate located on the cover of your water heater. The minimum and maximum inlet gas pressures are:

Natural Gas	Min. 5" WC - Max. 10.5" WC
Propane Gas	Min. 11" WC - Max. 14" WC

Gas pressure below this specified range for the T-K2 and/or insufficient gas volume will adversely affect performance. Inlet gas pressure must not exceed the above maximum values; gas pressure above the specified range will cause dangerous operating conditions and damage to the unit. Until testing of the main gas line supply pressure is completed, ensure the gas line to the T-K2 is disconnected to avoid any damage to the water heater.

Size the gas pipe appropriately to supply the necessary volume of gas required for the T-K2 (185,000 BTUH) using ANSI233.1/NAPA 54 in the USA or CAN/CSA B149.1 in Canada or local codes. Install a manual gas shut-off valve between the T-K2 and the gas supply line. When the gas connections are completed, it is necessary to perform a gas leak test either by applying soapy water to all gas fittings and observing for bubbles or by using a gas leak detection device. Always purge the gas line of any debris before connecting to the heater gas inlet.

**Pipe Sizing Example:** This table below is for Natural gas piping supply straight to the water heater without any tabs to other gas appliances

Recommend Gas pipe size for T-K2 Water Heater (Example for NG)	
Distance from Gas Meter	Pipe Size (inches)
0' - 30'	3/4"
30' - 100'	1"
100' - 200'	1-1/4"

## Natural Gas Supply Piping

Maximum Capacity of Natural Gas Based on a 0.60 specific gravity at a 0.5" WC pressure drop

Pipe Size	kBTU of Natural Gas												
Length	10'	20'	30'	40'	50'	60'	70'	80'	90'	100'	125'	150'	200'
¾"	372	255	205	175	156	142	130	121	114	107	95	86	74
1"	702	482	387	331	293	266	245	228	213	202	179	162	139
1 ¼"	1441	990	795	680	603	546	503	468	439	415	367	332	285
1 ½"	2158	1483	1191	1019	903	819	753	701	658	621	550	499	427
2"	4155	2856	2293	1963	1740	1576	1450	1349	1266	1195	1060	960	822

## Propane (LP) Gas Supply Piping

Maximum Capacity of Propane (LP) Gas Based on 11" WC supply pressure at a 1.0" WC pressure drop

Pipe Size	kBTU of Propane												
Length	10'	20'	30'	40'	50'	60'	70'	80'	90'	100'	125'	150'	200'
¾"	567	393	315	267	237	217	196	185	173	162	146	132	112
1"	1071	732	590	504	448	409	378	346	322	307	275	252	213
1 ¼"	2205	1496	1212	1039	913	834	771	724	677	630	567	511	440
1 ½"	3307	2299	1858	1559	1417	1275	1181	1086	1023	976	866	787	675
2"	6221	4331	3465	2992	2646	2394	2205	2047	1921	1811	1606	1496	1260

### WATER CONNECTIONS

#### FOR YOUR SAFETY, READ BEFORE OPERATING:

Do not use this water heater if any part has been submersed under water. Immediately call a qualified service technician to inspect the water heater and to replace any damaged parts.

All pipes, pipe fittings, valves and other components, including soldering materials, must be suitable for potable water systems. A manual shut off valve must be installed on the cold water inlet to the water heater between the main water supply line and the T-K2. In addition, a manual shut off valve is also recommended on the hot water outlet of the unit. If the T-K2 is installed within, or subjected to, a closed loop water system, such as one having an anti-backflow device in the cold water supply line, a thermal expansion tank must be installed. Contact the water supplier or local plumbing inspector on how to control this situation.

After installation of the water heater is complete, purge the water line to remove all the debris and air from the line. Failure to do so may cause damage to the heater. There is a wire mesh filter within the cold inlet to trap debris from entering your heater. This will need

to be cleaned periodically to maintain optimum flow.

#### Unit Draining & Filter Cleaning Procedures

To drain your unit, please follow these instructions carefully:

1. Turn off the power supply to the T-K2 Water Heater.
2. Close the manual gas shut off valve located on the gas supply line.
3. Close the manual water shut off valve located on the water supply line.
4. Open all hot water taps in the house. (Bathroom, kitchen, laundry room, etc.). When the residual water flow has ceased, close all hot water taps.
5. Have a bucket or pan to catch the water from the unit's drain plugs. Remove the drain plugs to drain all the water out of the unit.
6. Wait a few minutes to ensure all water has drained from unit.
7. At this time, please check the water filter located within the cold inlet. With a tiny brush, clean the water filter of any debris which may have accumulated and reinsert the filter back into the cold water inlet.
8. Securely screw the drain plugs back into place. Hand-tighten only

**To re-start your heater, follow these steps:**

1. Make sure all hot water taps are closed and the drain plugs are securely attached.
2. Purge the water line of debris.
3. Open the manual water shut-off valve located on the water supply line.
4. Open all the hot water taps to verify water flows to the taps. Then close the hot water taps.
5. Open the manual gas shut-off valve located on the gas supply line.
6. Turn on the power supply to the T-K2 Water Heater.

**Note:** Do not reverse the hot outlet and cold inlet connections to the T-K2 Water Heater. This will not activate the water heater.

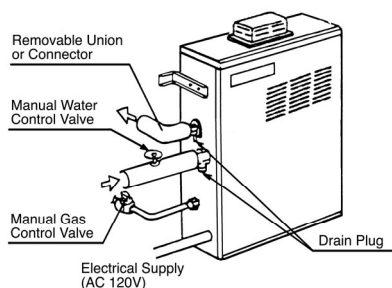

**Pressure Relief Valve**

The FLASH T-K2 has a high-temperature shut off switch built in as a standard safety feature (called a Hi-Limit switch) therefore a “pressure only” relief valve is required.

This unit does not come with an approved pressure relief valve. An approved pressure relief valve must be installed on the hot water outlet. The pressure relief valve must conform to ANSI Z21.22 or CAN 1-4.4 and installation must follow local code.

The discharge capacity must be at least 185,000 BTU/hr. The discharge piping for the pressure relief valve must be directed so that the hot water cannot splash on anyone or on nearby equipment. Attach the discharge tube to the pressure relief valve and run the end of the tube to within 6" from the floor. This discharge tube must allow free and complete drainage without any restrictions.

If the pressure relief valve installed on the T-K2 discharges periodically, this may be due to a defective thermal expansion tank or defective pressure relief valve.

The pressure relief valve must be manually operated periodically to check for correct operation.

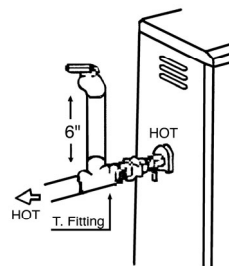

**ELECTRICAL CONNECTIONS**

**WARNING:** Follow the electrical code requirements of the local authority having jurisdiction. In the absence of such requirements, follow the latest edition of the National Electrical Code ANSI/NFPA 70 in the U.S. or the latest edition of CSA C22.1 Canadian Electrical Code, Part 1, in Canada.

The heater must be electrically grounded. Do not attach the ground wire to either the gas or the water piping. Plastic pipe or dielectric unions may isolate the water heater electrically.

**CAUTION:** When servicing or replacing parts within the T-K2, label all wires prior to disconnection to facilitate an easy and error free reconnection. Wiring errors can cause improper and dangerous operation. Verify proper operation after servicing.

The FLASH T-K2 water heater requires AC 120V 60 Hz electrical power supply that is properly grounded.

- An on/off switch controlling the main power to the T-K2 must be provided for service reasons;
- Connect the power supply to the T-K2 exactly as shown in the wiring diagram;

A green screw is provided in the junction box to ground the connection.

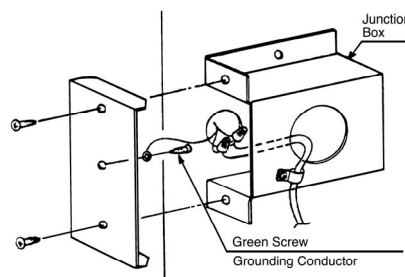

**Wiring diagrams are also located on the inside panel of the appliance.**

## INITIAL OPERATION

### For your safety please read before operating the unit for the first time.

Once you have properly installed the unit and before firing it for the first time, check the gas and water connections for leaks. Open the main gas supply valve to the unit using only your hand to avoid any spark. Never use tools. If the knob will not turn by hand, do not try to force it; call a qualified service technician. Force or attempted repair may result in a fire or explosion due to gas leaks. Be sure to check next to the bottom of the unit because some gases are heavier than air and may settle towards the floor.

### CAUTION: IF YOU SMELL GAS:

1. Do not try to start the water heater.
2. Do not touch any electric switch; do not use any phone in your building.
3. Immediately call your gas supplier from a neighbor's phone. Follow the gas supplier's instructions.
4. If you cannot reach your gas supplier, call the fire department.

This water heater does not have a pilot light. It is equipped with an electronic ignition device which automatically lights the burner. Do not try to light the burner manually. Check for proper venting and combustible air to the heater. Purge the gas and water lines to remove any air pocket. Do not use this water heater if any part has been submersed under water. Immediately call a qualified service technician to inspect the water heater and to replace any parts that have been under water.

Once the above checks have been completed, follow these steps to turn on your unit:

1. Close the manual gas control valve located on the gas line.
2. Fully open the manual water control valve on the water supply line.
3. Open a hot water tap to verify that water is flowing to that tap. Then close the hot water tap.
4. Fully open the manual gas control valve installed.
5. Turn on the 120 volt 60 Hz power supply to the FLASH T-K2 water heater.
6. Now you are ready to enjoy hours of endless hot water.

## NORMAL OPERATION

To Turn on Your FLASH T-K2 water heater.

1. Open a hot water tap.
2. Burners ignite. "Fire On" lamp is lit.

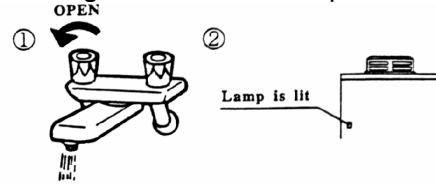

3. Mix cold water with the hot to get the correct temperature water.

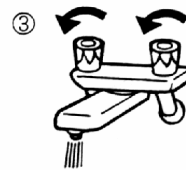

To "Turn off your FLASH water heater

1. Close the hot water tap

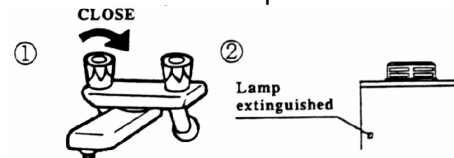

"Fire On" lamp extinguishes.

## FLOW

The flow rate through the FLASH T-K2 is limited to a maximum of 6.9 GPM. The temperature setting, along with the supply temperature of the water will determine the flow rate output of the unit. Please refer to the temperature/gallons per minute chart at the back of this manual to determine the likely flow rates based on your local ground water temperature and your desired outlet water temperature combination.

Based on the United States Department of Energy method of testing water heater output, the T-K2 is rated for 228 gallons per hour (GPH), or 3.8 gallons per minute (GPM), when raising the water temperature by 77°F (for example from 43°F to 120°F). Refer to the following chart of typical household plumbing fixture flow rates to determine what the FLASH T-K2 can do in a household application.

**Household Flow Rates**

Appliance / Use	Flow Rate (GPM)
Lavatory Faucet	1.0
Bath Tub	4.0
Shower	2.0
Kitchen Sink	1.5
Dishwasher	1.5
Washing Machine	2.0

Taken from UPC 1997

**WARNING**



Hot Water Heater temperatures over 125°F can cause severe burns instantly or death from scalding. The outlet hot water temperature of the FLASH T-K2 water heater is factory set at 122°F. Feel the water temperature before bathing or showering. Do not leave children, the disabled or the elderly unattended as they are at the highest risk of being scalded. Temperature limiting valves are available, ask professional person.

**TEMPERATURE SETTINGS**

There are 4 preset temperatures that you can select from by adjusting the dipswitch settings on the computer board. The temperature has been preset at the factory to 122°F (50°C). The computer will electronically control this temperature. At a fixture, mix cold water with hot to get the water temperature you desire. If you desire a hot water temperature other than the 4 preset settings, please purchase the optional temperature remote controller (part No. TK-RE02). With this optional TK-RE02 you can set the temperature from 99°F to 176°F. Please carefully read the instructions prior to installing the TK-RE02 as failure to do so could

damage the temperature controller and/or the water heater, which will void the warranty.

**Hot Water Output Temperature Setting:**

With the FLASH T-K2 Water Heater, the output hot water temperature can be adjusted either manually from the main computer board's dipswitches or with the optional remote controller (Part TK-RE02, from 99°F to 176°F). The dipswitches can set four hot water output temperatures 104°F, 113°F, 122°F, and 176°F (the factory set temperature is 122°F). could damage the temperature controller and/or the water heater, which will void the warranty.

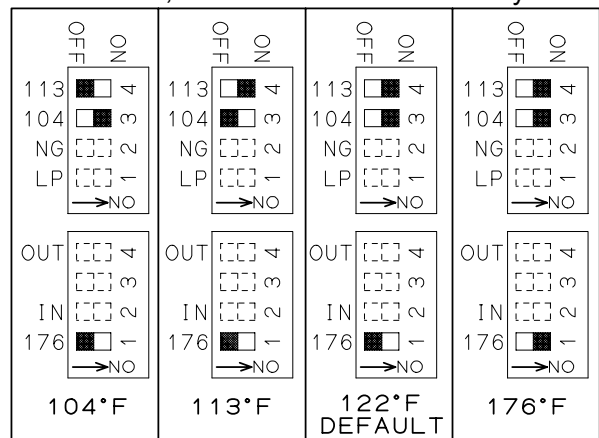

**FREEZE PROTECTION DEVICES**

This unit comes equipped with heating blocks to prevent freezing which can damage the heat exchanger. For this freeze prevention system to operate, there has to be electrical power to the unit. Damage to the heat exchanger caused by freezing temperatures due to power loss is not covered under the warranty.

The unit has been rated for temperatures down to 5°F (-15°C) in a wind free environment. If you install the water heater in an area that is subject to temperatures (including wind chill) below 5°F (-15°C), this will void the warranty and Takagi will not be responsible for any damage to the heat exchanger as a result of freezing. In any areas subject to freezing temperatures, Takagi strongly recommends the use of its back flow prevention flue damper (Part No. TK-TV03) to reduce the amount of cold air entering through the exhaust venting when the water heater is off.

If you will not be using your heater for a long period of time or if the temperatures (including the wind chill) will drop below 5 °F (-15 °C), turn off your heater and drain the unit of water

(see 'Unit Draining & Filter Cleaning' section above for draining instructions). This will keep your unit from freezing and being damaged.

For indoor installation in areas where the temperature will be well below freezing for extended periods of time, use the "thermostat extension cable" to relocate the internal thermostat located on the fan motor to the outdoors. This will sense the ambient air temperature and turn the internal heater blocks on to help prevent the heat exchanger from freezing.

The thermostat is attached to the motor fan. Remove the thermostat from the fan and extend the cable to locate the thermostat outdoors where it can get a better ambient temperature reading.

**CAUTION:** Only the pipes within the water heater are protected by the anti-freeze devices on the T-K2. Any hot or cold water pipes located outside of the unit will not be protected. Properly protect and insulate these pipes from freezing.

**CAUTION:** Label all wires prior to disconnection when servicing controls. Wiring error can cause improper and dangerous operation. Verify proper operation after servicing.

The FLASH T-K2 water heater requires an electrical power supply from 120 VAC 60 Hz circuit and be properly grounded.

- A means for switching on/off the 120 VAC power supply must be provided for service reasons.
- Wire the heater exactly as shown in the wiring diagram.
- A green screw is provided in the junction box for grounding connection.

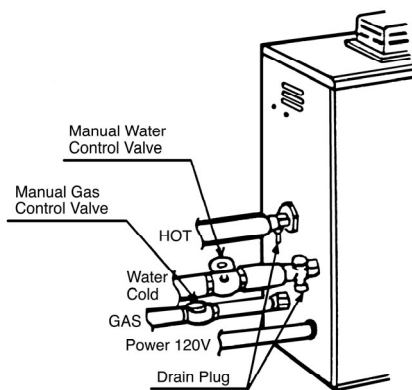

## MAINTENANCE AND SERVICE

**WARNING:** Turn off the electrical power supply and close the manual gas control valve and the manual water control valve before servicing.

**Do this immediately after installation.**

1. Clean the cold-water inlet filter (figure below).

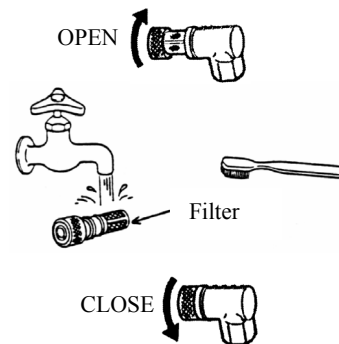

2. Be sure that all openings for combustion and ventilation air are not blocked.
3. Check that the exhaust vent pipe is not blocked.
4. Check the gas pressure.
5. Keep the area around the water heater clear. Remove any combustible materials, gasoline or any flammable vapors and liquids.

The unit should be checked once a year or as necessary by a licensed technician. If repairs are needed, any repairs should be done by a licensed technician.

The following systems and parts should be checked at least once a year:

1. Venting system
2. Burner
3. Manual operation of the pressure relief valve to ensure correct operation.
4. Periodic cleaning of the water filter (figure above).
5. Heat exchanger. Remove the thermistor and check for a mineral coating. A mineral coating on the thermistor requires flushing the heat exchanger with a de-scaling solution. Scale build up will void your warranty and shorten the life of your water heater.

## Common Trouble Shooting

The T-K2 can burn gas at a maximum input rate of 185,000 BTUH. This puts a limit on the possible output temperature and flow capabilities. If the water doesn't seem hot enough, compare the flow and temperature that is being attained to the T-K2 flow vs. temperature chart (See flow chart on the last page of this manual). If the unit is not performing according to the chart, first check that the gas supply pipe is sized properly and that the gas pressure is within the required range. If the gas line is sized properly, check the plumbing for mixing valves, thermostatic valves, anti-scald devices, single handled faucets with built in temperature or pressure compensators valves and hot and cold crossed connections. If the unit is performing in accordance with the flow chart, it may be undersized for the application. If the unit is performing according to the chart, the output temperature can be adjusted using the TK-RE02 or the dipswitches on the unit.

### It Takes Too Long to Get Hot Water

The T-K2 takes three seconds to ignite and three more seconds to heat the incoming ground water up to the set temperature. The time it takes to deliver hot water from the T-K2 to your fixtures depends on the length of piping between the two. The longer the distance, the more time it will take. If you would like to receive hot water to your fixtures quicker, you may want to consider a hot water recirculation system.

### The T-K2 Will Not Initiate

First check the flow rate through the unit. If the flow is less than .75 GPM, the unit will not initiate. Check the filter for any debris or damage. If you have installed a combination system (a T-K2 doing both domestic hot water and space heating), completely isolate the heating system temporarily to ensure flow is not backfeeding through your heating system to supply the domestic water (by-passing the T-K2).

If neither of those remedies start the unit, press the lower grey button marked "test (off)" on the GFCI inside the unit. If the red light above it does not come on, there is a problem with the electrical supply to the unit. If that red light does come on, hit the "reset (on)" button and open a hot water faucet to re-try the unit. If the problem persists contact Takagi for instructions

### ERROR CODES

All Takagi units are self diagnostic for safety and convenience when trouble shooting. If there is a problem with the installation or the unit, it will display a numerical error code on the TK-RE02 (if installed) or at the bottom left corner of the computer board to communicate the source of the problem. Consult the following chart for the cause of an error code:

The T-K2 consists of five major control operations: Temperature control, Gas control, Water control, Burner Control, and Main computer control.

Computer Board	TK-RE02	Check Point
Burning (red) LED: Blinking Power (green) LED: OFF	11	Igniter
	12	Flame Detector
	51	Main Gas Valve
	72	Pre Post Check
Burning (red) LED: OFF Power (green) LED: Blinking	03	Wrong Gas, Dip Switch
	14	Hi-Limit Switch
	70	Computer Board
	71	Proportional Valve
Burning LED and Power LED: Blinking Alternately	61	Fan Motor
	21	Vent Pipe
Burning LED and Power LED: Blink Simultaneously	31	Thermistor
	65	Water Control Valve



# Wiring Diagram

# T-K2

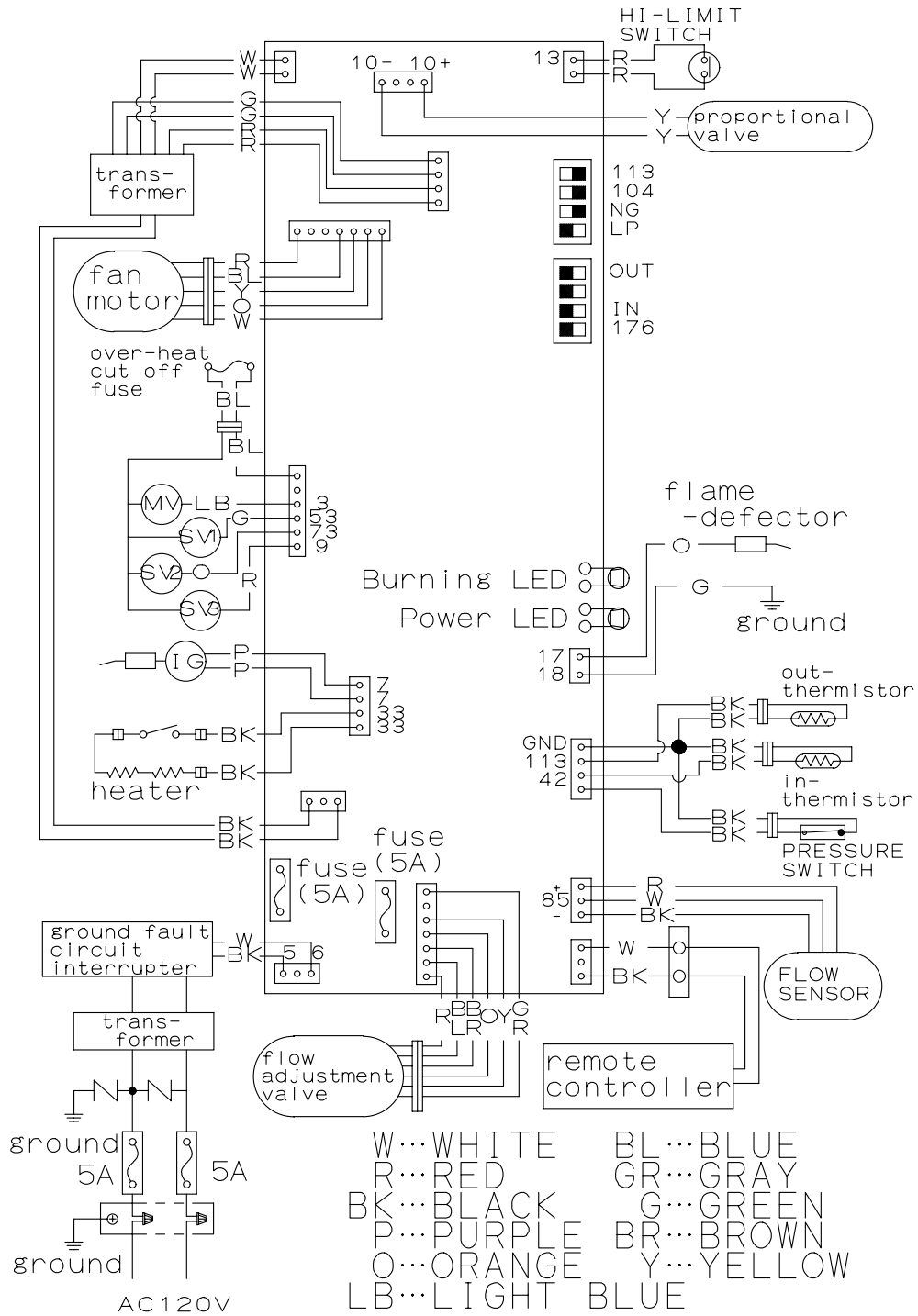

## Wiring Diagram

A wiring diagram is located on the inside front panel of the appliance.

Electrical Rating: 120 VAC, 60 Hz, 0.8 A.

**Note:** If any of the original wiring supplied with this appliance must be replaced, it must be replaced with appliance wiring material (180c) or its equivalent. Replacement wires are available through Takagi.

## FOR YOUR SAFETY READ BEFORE OPERATING

**WARNING:** If you do not follow these instructions exactly, a fire or explosion may result causing property damage, personal injury or loss of life.

- A. This water heater does not have a pilot. It is equipped with an ignition device that automatically lights the burner. Do not try to light the burner by hand.
- B. BEFORE OPERATING smell all around the water heater area for evidence of leaking gas. Be sure to smell next to the floor because some gas is heavier than air and will settle on the floor.

### WHAT TO DO IF YOU SMELL GAS.

- Do not try to light any appliance.
  - Do not touch any electric switch, do not use any phone in your building
  - Immediately call your gas supplier from a neighbor's phone. Follow the gas supplier's instructions.
  - If you cannot reach your gas supplier, call the fire department.
- C. Use only your hand to turn the gas valve knob. Never use tools. If the knob will not turn by hand, don't try to repair it. Call a qualified service technician. Force or attempted repair may result in a fire or explosion.
  - D. Do not use this water heater if any part has been under water. Immediately call a qualified service technician to inspect the water heater and to replace any damaged parts.

## OPERATING INSTRUCTIONS

1. **STOP!** Read the safety information above or in the Owners Manual.
2. Turn off all electric power to the water heater.
3. Do not attempt to light the burner by hand.
4. Turn the gas manual gas valve located on the outside of the unit clockwise ☺ to the off position.
5. Wait five (5) minutes to clear out any gas. If you then smell gas. STOP! Follow "B" in the safety information above on this label. If you don't smell gas, go to next step.
6. Turn the manual gas valve located on the outside of the unit counter clockwise ☹ to the ON position.
7. Turn on all electrical power to the water heater.
8. If the water heater will not operate, follow the instructions "to Turn Off Gas to water heater" and Call your service technician or gas supplier.

## TO TURN OFF GAS TO APPLIANCE

1. Turn off all electric power to the water heater if service is to be performed.
2. Turn the manual gas valve located on the outside of the unit clockwise ☺ to the off position.

## DANGER



**Vapors from flammable liquids will explode and catch fire causing death or severe burns.**  
Do not use or store flammable products such as gasoline, solvents or adhesives in the same room or area near the water heater.

Keep flammable products:

1. Far away from heater.
2. In approved containers.
3. Tightly closed
4. Out of children's reach

Vapors:

1. Cannot be seen
2. Vapors are heavier than air
3. Go a long way on the floor
4. Can be carried from other rooms to the main burner by air currents.

**WARNING: Do not install water heater where flammable products will be stored.**

**Read and follow water heater warnings and instructions. If owner's manual is missing, contact the retailer or manufacturer.**

## WARNING

The outlet hot water temperature of the T-K2 water heater is factory set at 122 °F.  
**WARNING:** Use this heater at your own risk. The set outlet water temperature can cause severe burns instantly or death from scalds. Test the water before bathing or showering.  
Do not leave children or the infirm without supervised.

## DANGER

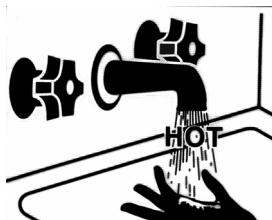

Hot Water Heater temperature over 125 °F can cause severe burns instantly or death from scalding. Children, disabled and elderly are at the highest risk of being scalded. Feel water temperature before bathing or showering. Temperature limiting valves are available, ask professional person.

**WARNING:** California Proposition 65 lists chemical substances known to the state to cause cancer, birth defects, death, serious illness or other reproductive harm. This product may contain such substances, be their origin from fuel combustion (gas, oil) or components of the product itself.

# Applications

## Space Heating Applications

The T-K2 can be used for potable hot water heating applications as well as space heating applications.

### WARNING

- Toxic chemicals used in boiler treatments such as alcohol, glycerol and glycol group must not be introduced into the system when used for open loop potable water and space heating.
- The FLASH T-K2 can be used to supply potable water and space heating and shall not be connected to any heating system or component(s) previously used with non-potable water where any chemicals were added to the water heating appliances.
- When the system requires water for space heating at temperatures higher than required for other uses, a means such as a mixing valve shall be installed to temper the water for those other uses in order to reduce scald hazard potential.
- Water temperature over 125 °F can cause severe burns instantly or death from scalds.
- Chemicals such as diluted Glycol can be used for radiant floor, Hydro/fan coil air or Baseboard heating only.

### Basic System Drawings and Schematics

Heating application only:

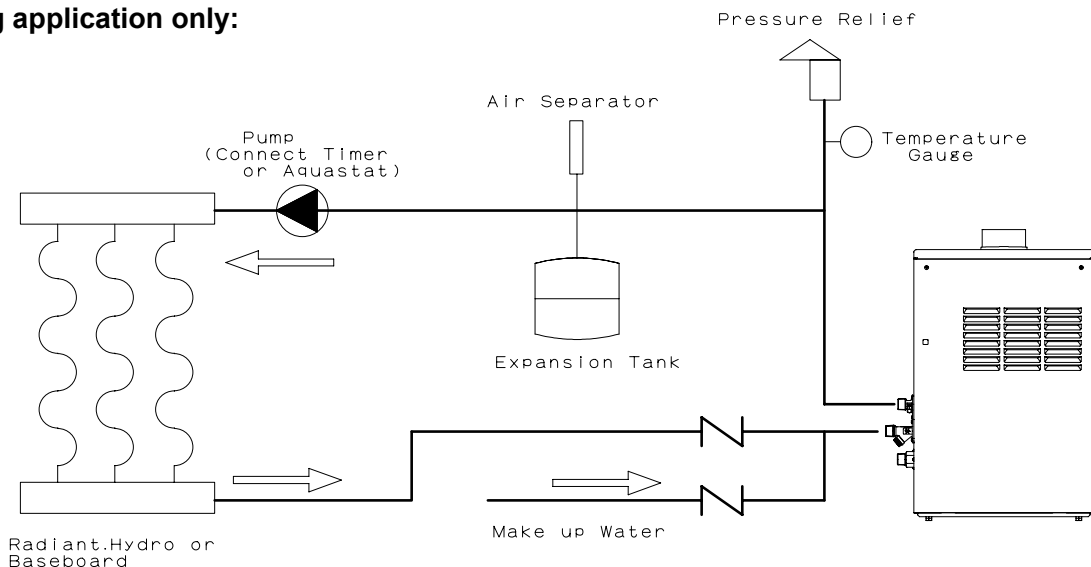

**Warning:** This illustration is for concept only. There are a wide variety of variations to the application of controls and equipment presented applications. Designers must add all necessary safety and auxiliary equipment to conform to code requirements and design practice. For more details, contact Technical Department at (888) 882-5244

Dual-purpose hot water heating (Domestic and Space Heating)

## Diagrammatic Layout of Radiant Heating and Domestic Water Heater

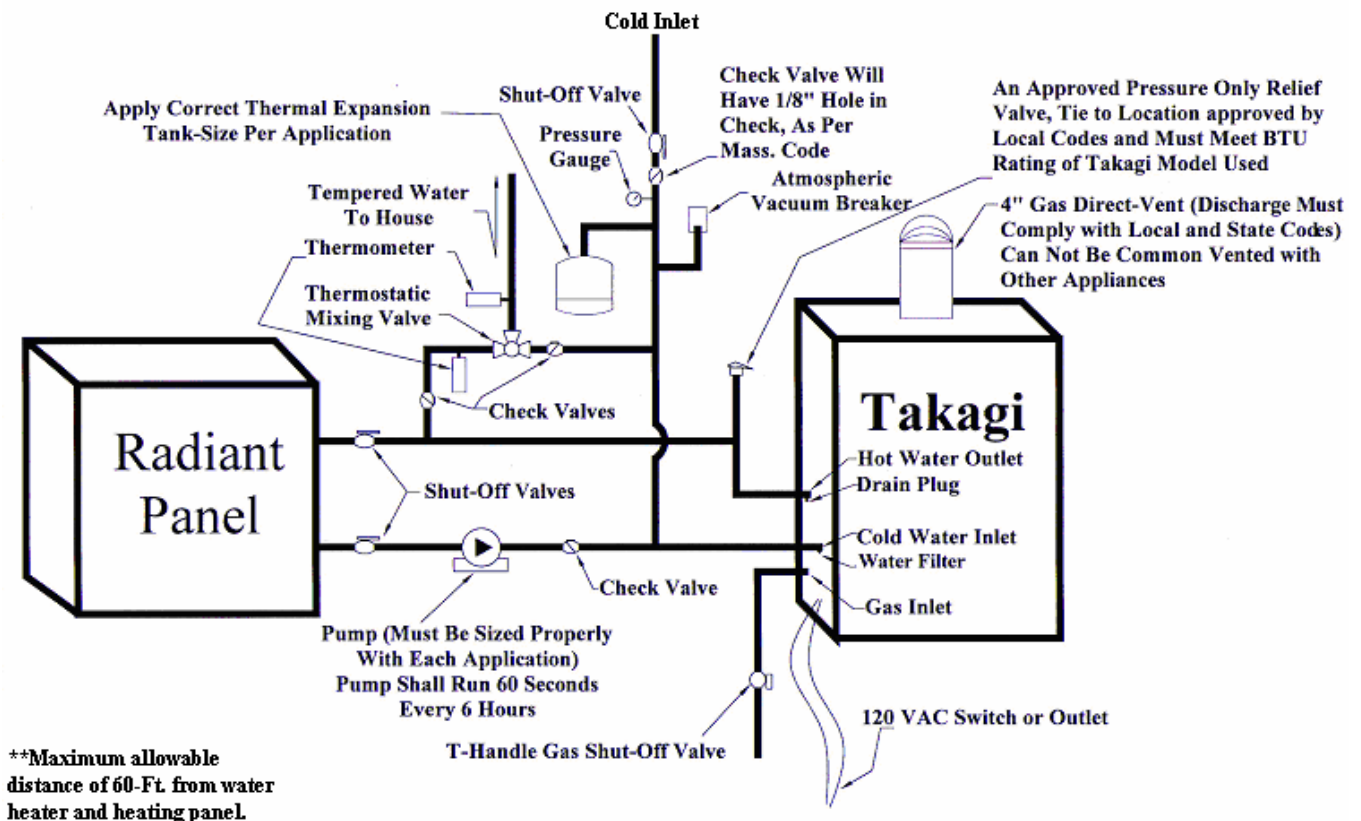

**Priority Control Devices** such as a flow switch, an Aquastat or other electronic controller can be used to prioritize the domestic water system over the heating system.

**Warning:** Follow all local codes, or in the absence of local codes, follow the most recent edition of the National Standard Code, ANSI Z21. 10.3.

**Warning:** This illustration is a concept design only. The reference to the 1/8<sup>th</sup> hole in check is only for the State of Massachusetts. There are a wide variety of variations to the application of controls and equipment presented. Designers must add all necessary safety and auxiliary equipment to conform to code requirements and design practice. For more details, contact the Takagi Technical Department at (888) 882-5244

## T-K2 with Storage Tank

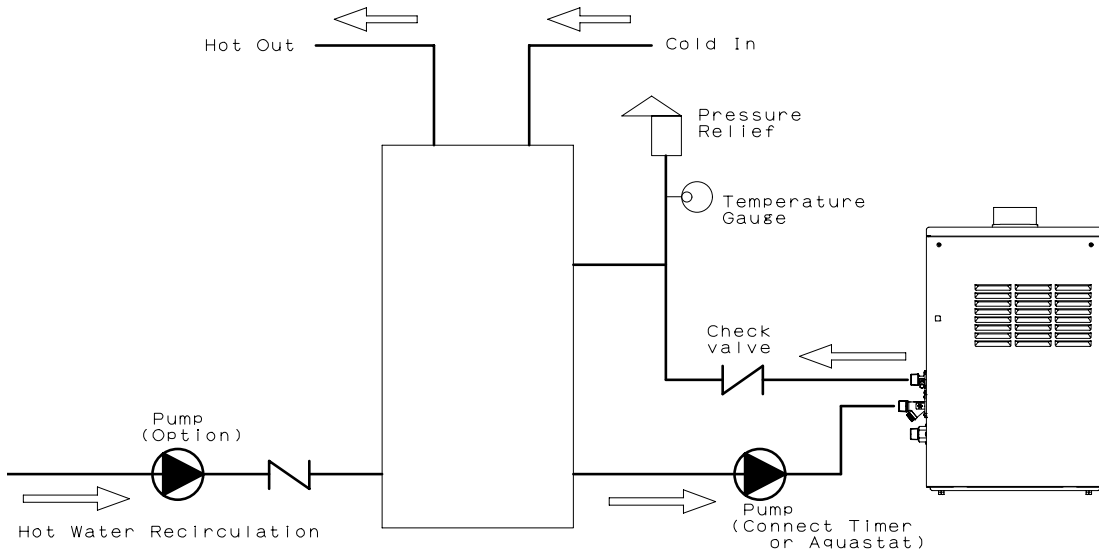

This illustration is a concept design only. The maximum flow rate through the T-K2 is 6.9 GPM. If it is necessary to achieve higher flow rates with full pressure for longer periods of time, then it can be installed in conjunction with a storage tank. A pump will be necessary to keep the storage tank water hot. We suggest a **high-head** pump of 1/12 hp or greater depending on the system.

## Recirculation

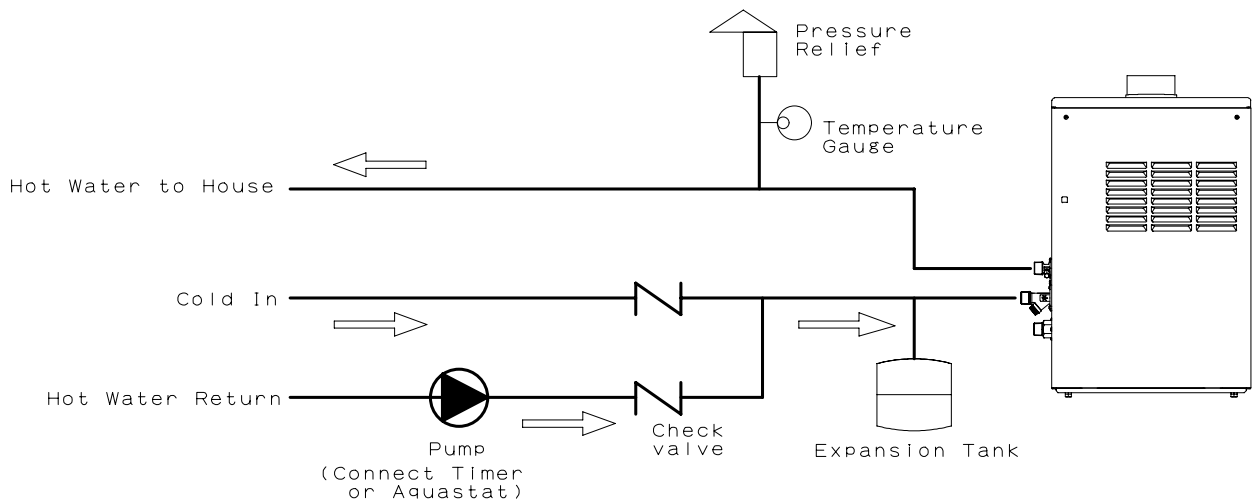

This illustration is a concept design only. This system will also need a **high-head** pump of 1/12 hp or greater, depending on the application situation.

## Optional Items

### 1. TK-RE02 Temperature Remote Controller



The TK-RE02 Temperature Remote Controller has two functions. It allows the output temperature from the T-K2 to be adjusted within the range of 99 °F to 176 °F, and it also works as a diagnostic tool that will give a concise error code whenever there is a problem with the unit. The temperature options are 99°F, 100°F, 102°F, 104°F, 106°F, 108°F, 109°F, 111°F, 113°F, 115°F, 117°F, 122°F, 131°F, 140°F, 158°F, and 167°F or 176°F. See the trouble shooting section for information on possible error codes.

### 2. TK-TV01 Vent Terminator



This terminator can be used where a T-K2 is going to be vented out through a wall. This is a CSA tested Takagi component. Connect the Category III stainless steel vent pipe from the top of the unit to the backside of this terminator to exhaust flue gases through the wall without a thimble. Install this vent terminator in accordance with Takagi's installation instructions and any applicable codes.

### 3. TK-TV03 Vent Damper



The TK-TV03 Vent Damper prevents the backflow of air through the exhaust vent. This is a CSA tested Takagi component. This helps prevent harmful exhaust gases from entering the home, as well as helping to prevent the unit from freezing in areas where cold air can be blown or drawn into the exhaust system. Install this vent damper in accordance with Takagi's installation instructions, and any applicable codes.

### 4. TK-TV04 Vent Cap



The TK-TV04 Vent Cap is for outdoor installation with the T-K2 water heater. The cap is installed on the top of the unit, instead of connecting an exhaust vent pipe. The cap will prevent any debris that might be in the environment from entering the unit and causing damage or a fire hazard, as well as preventing rain or other weather from entering the unit.

### 5. TK-BK01 Wall Mounting Brackets



The TK-BK01 Wall Mounting Brackets allow the T-K2 to be installed hanging from a wall. It is not necessary to earthquake strap these heaters if these brackets are used. If the unit is not going to be mounted on a wall, the "L" brackets that are included with every unit will be sufficient as earthquake protection. Install unit and brackets according to manufacturer's installation instructions and any applicable codes.

# Component Diagram

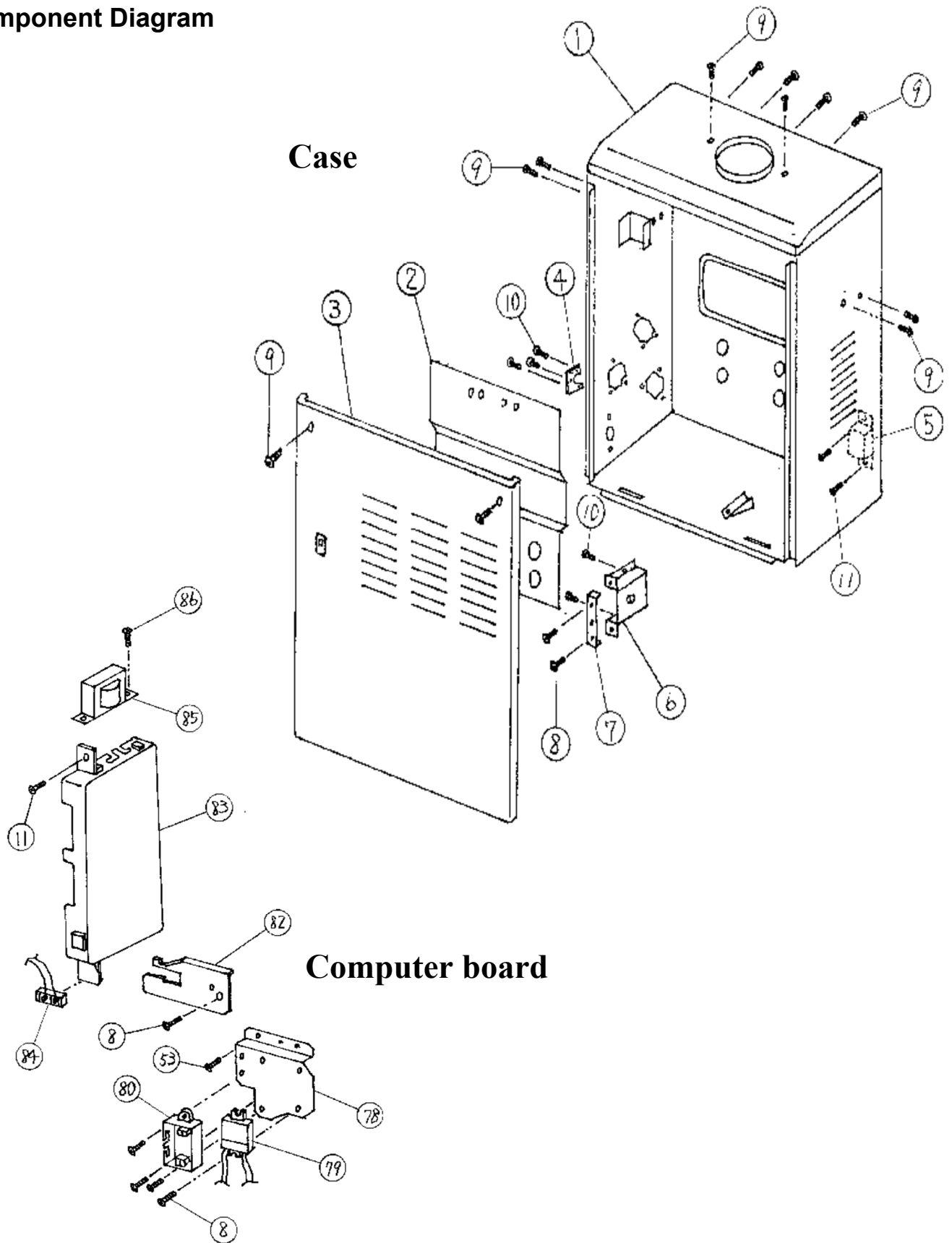



**Burner**

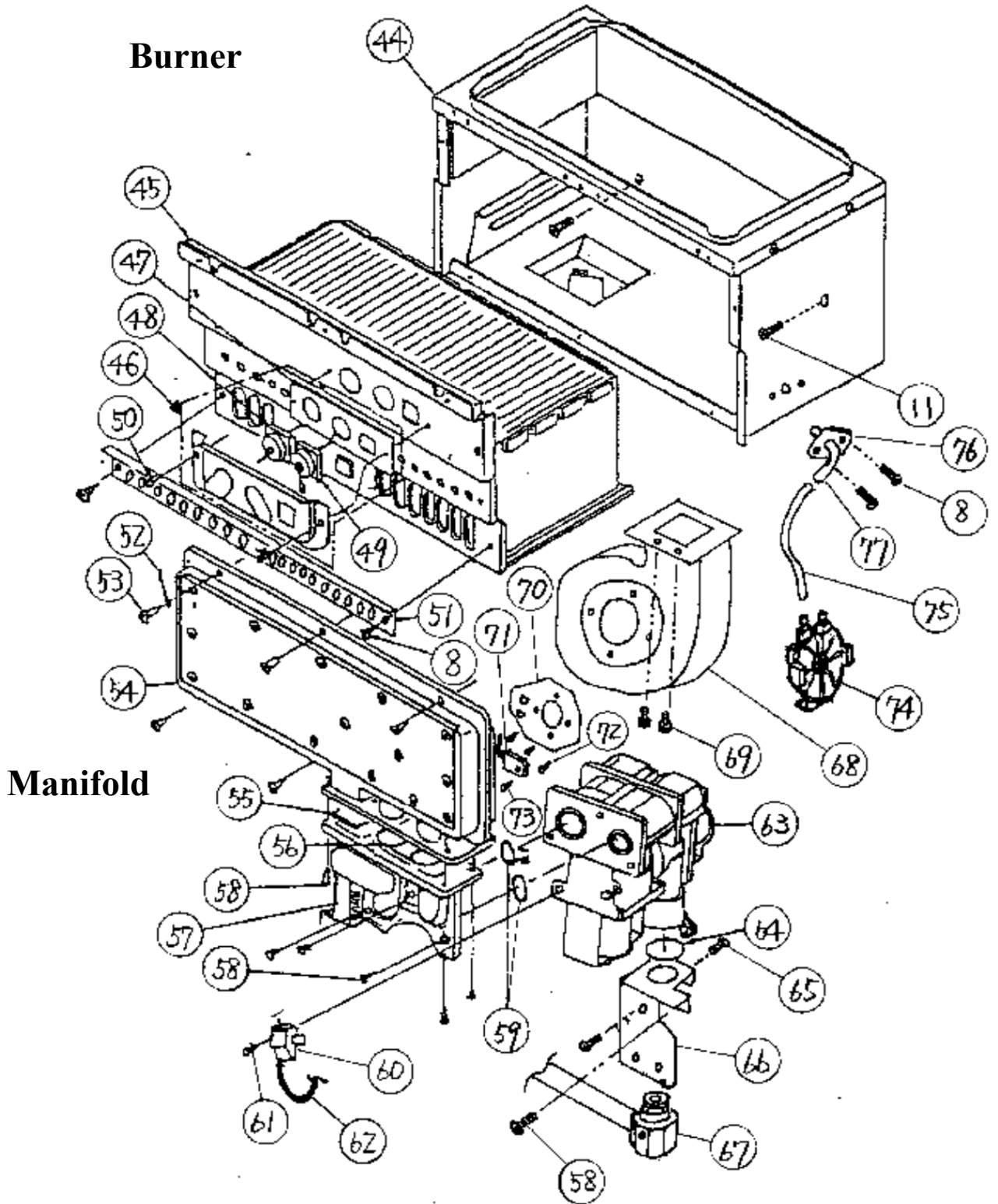

**Manifold**

# Heat Exchanger

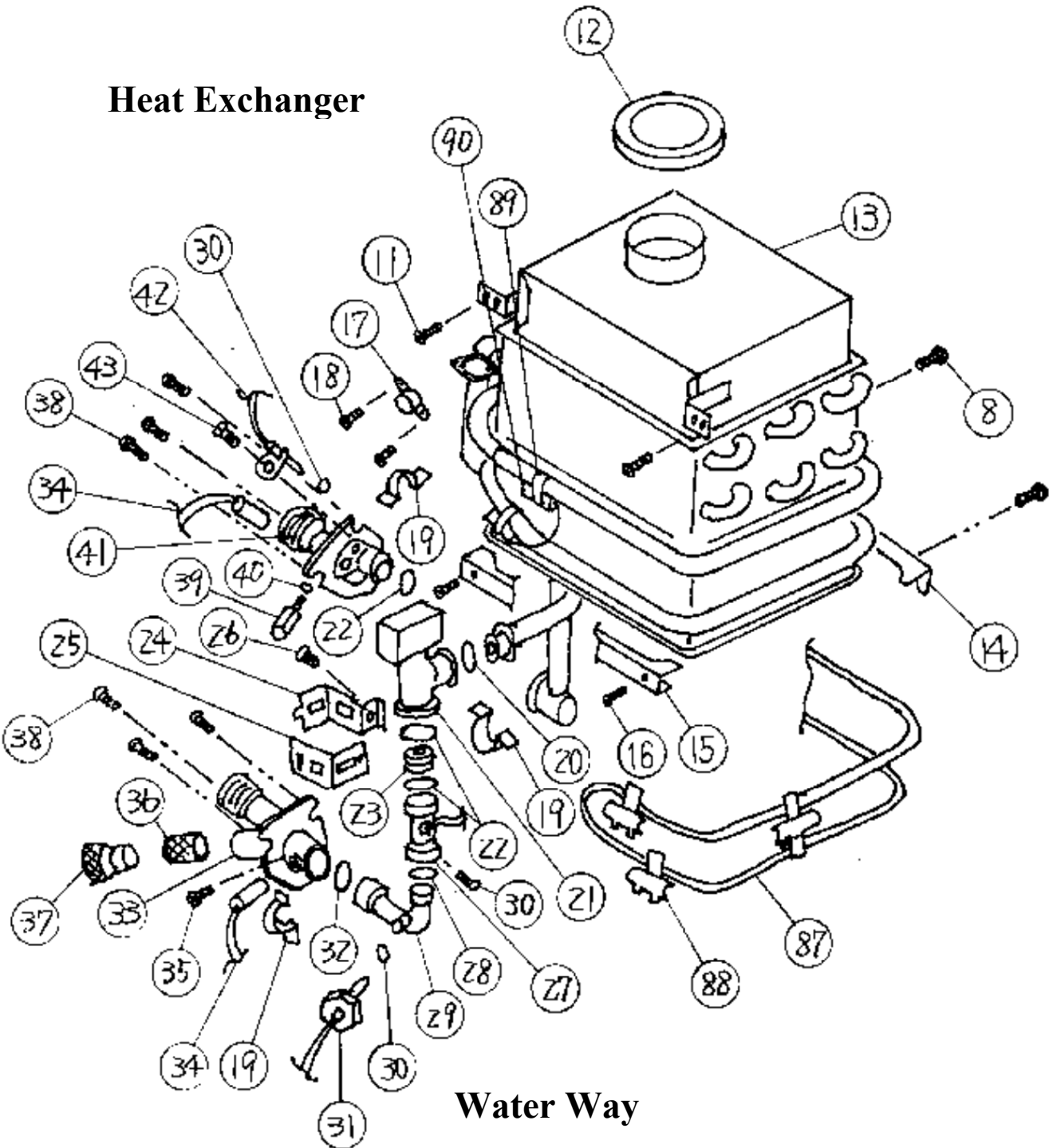

## T - K2 PARTS LIST

1	CASE ASSEMBLY	46	SCREW
2	BACK GUARD PANEL ASSEMBLY	47	SPARK ELECTRODE HOLDER
3	FRONT COVER	48	SPARK ELECTRODE
4	FIXING PLATE	49	FLAME SENSOR
5	TRANSFORMER	50	SCREW
6	JUNCTION BOX	51	DAMPER
7	JUNCTION BOX COVER	52	WIRE HOLDER
8	SCREW	53	SCREW
9	SCREW (COATED)	54	MANIFOLD
10	SCREW	55	GASKET
11	SCREW	56	GASKET
12	SILICON RING	57	GAS COUPLING
13	HEAT EXCHANGER ASSEMBLY	58	SCREW
14	HEAT EXCHANGER FIXING PLATE (BACK)	59	O-RING
15	HEAT EXCHANGER FIXING PLATE (FRONT)	60	IGNITER
16	SCREW	61	SCREW
17	HI-LIMIT SWITCH	62	IGNITER
18	SCREW	63	GAS VALVE UNIT
19	QUICK RELEASE PLATE	64	O-RING
20	O-RING	65	SCREW
21	WATER CONTROL VALVE	66	GAS INLET FIXING PLATE
22	O-RING	67	GAS INLET
23	GASKET	68	FAN
24	QUICK RELEASE PLATE	69	SCREW
25	QUICK RELEASE PLATE	70	FAN DAMPER
26	SCREW	71	THERMOSTAT
27	FLOW SENSOR	72	SCREW
28	O-RING	73	SCREW
29	INLET CONNECTION PIPE	74	PRESSURE SWITCH
30	O-RING	75	SILICON TUBE
31	INLET THERMISTOR	76	PRESSURE SWITCH PORTPLATE
32	O-RING	77	PRESSURE SWITCH PORT
33	WATER INLET	78	POWER DISTRIBUTION PLATE
34	FREEZE PROTECTION HEATER	79	GROUND FAULT CIRCUIT INTERRUPTER
35	SCREW	80	FUSE BOX
36	FILTER	82	COMPUTER FIXING PLATE
37	INLET DRAIN PLUG	83	COMPUTER BOARD
38	SCREW	84	REMOTE CONTROL CONNECTION
39	OUTLET DRAIN PLUG	85	COMPUTER TRANSFORMER
40	O-RING	86	SCREW
41	WATER OUTLET	87	OVERHEAT CUT-OFF FUSE
42	OUTLET THERMISTOR	88	OVERHEAT CUT-OFF FUSE FIXING PLATE
43	SCREW	89	FREEZE PROTECTION HEATER FIXING PLATE
44	COMBUSTION CHAMBER	90	FREEZE PROTECTION HEATER
45	BURNER ASSEMBLY		

### Out Put Temperature vs. GPM (Max.6.9 GPM) with Various Ground Water Temperature

Correct Gas pipe size can be expect this chart

